

# FLOS

60.3840.29 Aluminum

## Three Phase Track Recessed 4000 mm

Designed by FLOS Architectural, 2013

Length: 4000 - Wall recessed, Ceiling recessed

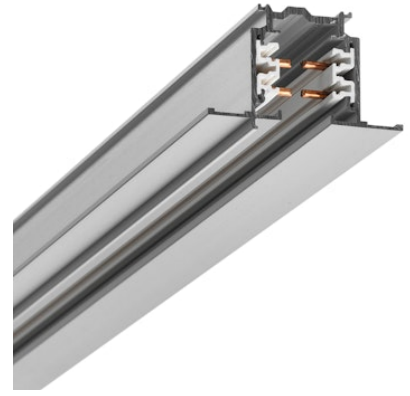

GLOBAL TRACK offers benefits for advanced installations: the main connectors are feedable and the feeding cable can be hidden under the elegant suspension accessories. GLOBAL TRACK lighting tracks are designed for easy surface mounting on ceilings and walls, or recessed mounting in suspended ceilings. Lighting tracks can be suspended at any desired height. Other advantages of the three-circuit system are its high loading capacity and the possibility of forming independent fixture groups in all three circuits. This permits illumination of the most demanding environments.

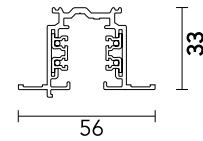

Are you a professional and your project needs consulting and support?

[BOOK AN APPOINTMENT](#)

### Main specifications

Mounting	Wall recessed, Ceiling recessed
Environments	Indoor dry location

### Physical

Colour	Aluminum
Trim	No
Length (mm)	4000
Net weight (kg)	4
IP internal	20
IP external	20

### Download

[Mounting instructions](#)

[↓ PDF](#)



## Electrical

Insulation class I

---

Emergency No

## Accessories & Power Supply



OPTIONAL  
Accessory

Installation

60.3016.11

Blind end



OPTIONAL  
Accessory

60.3016.12

Blind end



OPTIONAL  
Accessory

60.3016.14

Blind end



OPTIONAL  
Accessory

Installation

60.3022.11

Recessed box for fix-point



OPTIONAL  
Accessory

Installation

60.3022.14

Recessed box for fix-point



OPTIONAL  
Accessory

Installation

60.3023.11

Fix-point



OPTIONAL  
Accessory

Installation

60.3023.14

Fix-point



OPTIONAL  
Accessory

Electrical

60.3028.11

Connector 90° Outside



OPTIONAL  
Accessory

Electrical

60.3028.14

Connector 90° Outside



OPTIONAL  
Accessory

60.3028.29

Connector 90° Outside



OPTIONAL  
Accessory

Electrical

60.3029.11

Connector 90° Inside



OPTIONAL  
Accessory

Electrical

60.3029.14

Connector 90° Inside



OPTIONAL  
Accessory

Electrical

60.3029.29

Connector 90° Inside



OPTIONAL  
Accessory

Electrical

60.3036.11

Cross Coupling



OPTIONAL  
Accessory

Electrical

60.3036.14

Cross Coupling



OPTIONAL  
Accessory

Electrical

60.3036.29

Cross Coupling



OPTIONAL  
Accessory

Electrical

60.3043.11

Mean connector



OPTIONAL  
Accessory

Electrical

60.3043.14

Mean connector



OPTIONAL  
Accessory

Electrical

60.3043.29

Mean connector



OPTIONAL  
Accessory

Electrical

60.3044.11

Straight connector



OPTIONAL  
Accessory

Electrical

60.3044.12

Straight connector



OPTIONAL  
Accessory

Electrical

60.3044.14

Straight connector



OPTIONAL  
Accessory

Electrical

60.3046.11

Corner adjustable connector



OPTIONAL  
Accessory

Electrical

60.3046.14

Corner adjustable connector



OPTIONAL  
Accessory

Electrical

60.3046.29

Corner adjustable connector



OPTIONAL  
Accessory

Installation

60.3047.11

Connector T - Inside Right



OPTIONAL  
Accessory

Installation

60.3047.14

Connector T - Inside Right



OPTIONAL  
Accessory

Installation

60.3047.29

Connector T - Inside Right



OPTIONAL  
Accessory

Installation

60.3048.29

Connector T - Inside Left



OPTIONAL  
Accessory

Installation

60.3049.11

Connector T - Outside Right



OPTIONAL  
Accessory

Installation

60.3049.14

Connector T - Outside Right



OPTIONAL  
Accessory

Installation

60.3051.11

Connector T - Outside Left



OPTIONAL  
Accessory

Installation

60.3051.14

Connector T - Outside Left



OPTIONAL  
Accessory

Installation

60.3051.29

Connector T - Outside Left



OPTIONAL  
Accessory

Installation

60.3053.11

Cover for power supply  
connectors recessed track



OPTIONAL  
Accessory

Installation

60.3053.14

Cover for power supply  
connectors recessed track



OPTIONAL  
Accessory

Mounting

60.3054

Lead bending key



OPTIONAL  
Accessory

Installation

60.3146.11

Cover for connectors DALI



OPTIONAL  
Accessory

Installation

60.3146.14

Cover for connectors DALI



OPTIONAL  
Accessory

Electrical

60.3037.29ADA

DALI Flexible connector



OPTIONAL  
Accessory

Electrical

60.3037.14ADA

DALI Flexible connector

OPTIONAL  
Accessory

Electrical

60.3037.11ADA

DALI Flexible connector

OPTIONAL  
Accessory

Electrical

60.3038.14

Live end right

OPTIONAL  
Accessory

Electrical

60.3038.12

Live end right



OPTIONAL  
Accessory

Electrical

60.3038.11

Live end right

OPTIONAL  
Accessory

Electrical

60.3039.14

Live end left

OPTIONAL  
Accessory

Electrical

60.3039.12

Live end left

OPTIONAL  
Accessory

Electrical

60.3039.11

Live end left



OPTIONAL  
Accessory

Installation

60.3023.29

Fix-point



OPTIONAL  
Accessory

Installation

60.3048.14

Connector T - Inside Left



OPTIONAL  
Accessory

Installation

60.3048.11

Connector T - Inside Left