

FLOS

60.3830.14 Matte Black

Three Phase Track Recessed 3000 mm

Designed by FLOS Architectural, 2013

Length: 3000 - Wall recessed, Ceiling recessed

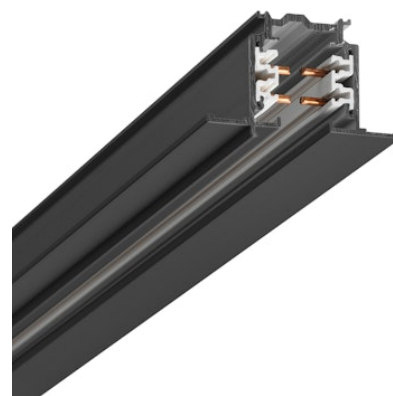

GLOBAL TRACK offers benefits for advanced installations: the main connectors are feedable and the feeding cable can be hidden under the elegant suspension accessories. GLOBAL TRACK lighting tracks are designed for easy surface mounting on ceilings and walls, or recessed mounting in suspended ceilings. Lighting tracks can be suspended at any desired height. Other advantages of the three-circuit system are its high loading capacity and the possibility of forming independent fixture groups in all three circuits. This permits illumination of the most demanding environments.

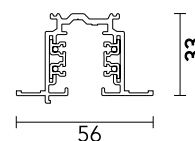

Are you a professional and your project needs consulting and support?

[BOOK AN APPOINTMENT](#)

Main specifications

Mounting	Wall recessed, Ceiling recessed
Environments	Indoor dry location

Physical

Colour	Matte Black
Trim	No
Length (mm)	3000
Net weight (kg)	3
IP internal	20
IP external	20

Download

[Mounting instructions](#)

[↓ PDF](#)



Electrical

Insulation class I

Emergency No

Accessories & Power Supply



OPTIONAL
Accessory

Installation

60.3016.11

Blind end



OPTIONAL
Accessory

60.3016.12

Blind end



OPTIONAL
Accessory

60.3016.14

Blind end



OPTIONAL
Accessory

Installation

60.3022.11

Recessed box for fix-point



OPTIONAL
Accessory

Installation

60.3022.14

Recessed box for fix-point



OPTIONAL
Accessory

Installation

60.3023.11

Fix-point



OPTIONAL
Accessory

Installation

60.3023.14

Fix-point



OPTIONAL
Accessory

Electrical

60.3028.11

Connector 90° Outside



OPTIONAL
Accessory

Electrical

60.3028.14

Connector 90° Outside



OPTIONAL
Accessory

60.3028.29

Connector 90° Outside



OPTIONAL
Accessory

Electrical

60.3029.11

Connector 90° Inside



OPTIONAL
Accessory

Electrical

60.3029.14

Connector 90° Inside



OPTIONAL
Accessory

Electrical

60.3029.29

Connector 90° Inside



OPTIONAL
Accessory

Electrical

60.3036.11

Cross Coupling



OPTIONAL
Accessory

Electrical

60.3036.14

Cross Coupling



OPTIONAL
Accessory

Electrical

60.3036.29

Cross Coupling



OPTIONAL
Accessory

Electrical

60.3043.11

Mean connector



OPTIONAL
Accessory

Electrical

60.3043.14

Mean connector



OPTIONAL
Accessory

Electrical

60.3043.29

Mean connector



OPTIONAL
Accessory

Electrical

60.3044.11

Straight connector



OPTIONAL
Accessory

Electrical

60.3044.12

Straight connector



OPTIONAL
Accessory

Electrical

60.3044.14

Straight connector



OPTIONAL
Accessory

Electrical

60.3046.11

Corner adjustable connector



OPTIONAL
Accessory

Electrical

60.3046.14

Corner adjustable connector



OPTIONAL
Accessory

Electrical

60.3046.29

Corner adjustable connector



OPTIONAL
Accessory

Installation

60.3047.11

Connector T - Inside Right



OPTIONAL
Accessory

Installation

60.3047.14

Connector T - Inside Right



OPTIONAL
Accessory

Installation

60.3047.29

Connector T - Inside Right



OPTIONAL
Accessory

Installation

60.3048.29

Connector T - Inside Left



OPTIONAL
Accessory

Installation

60.3049.11

Connector T - Outside Right



OPTIONAL
Accessory

Installation

60.3049.14

Connector T - Outside Right



OPTIONAL
Accessory

Installation

60.3051.11

Connector T - Outside Left



OPTIONAL
Accessory

Installation

60.3051.14

Connector T - Outside Left



OPTIONAL
Accessory

Installation

60.3051.29

Connector T - Outside Left



OPTIONAL
Accessory

Installation

60.3053.11

Cover for power supply
connectors recessed track



OPTIONAL
Accessory

Installation

60.3053.14

Cover for power supply
connectors recessed track



OPTIONAL
Accessory

Mounting

60.3054

Lead bending key



OPTIONAL
Accessory

Installation

60.3146.11

Cover for connectors DALI



OPTIONAL
Accessory

Installation

60.3146.14

Cover for connectors DALI



OPTIONAL
Accessory

Electrical

60.3037.29ADA

DALI Flexible connector



OPTIONAL
Accessory

Electrical

60.3037.14ADA

DALI Flexible connector



OPTIONAL
Accessory

Electrical

60.3037.11ADA

DALI Flexible connector



OPTIONAL
Accessory

Electrical

60.3038.14

Live end right



OPTIONAL
Accessory

Electrical

60.3038.12

Live end right



OPTIONAL
Accessory

Electrical

60.3038.11

Live end right



OPTIONAL
Accessory

Electrical

60.3039.14

Live end left



OPTIONAL
Accessory

Electrical

60.3039.12

Live end left



OPTIONAL
Accessory

Electrical

60.3039.11

Live end left



OPTIONAL
Accessory

Installation

60.3023.29

Fix-point



OPTIONAL
Accessory

Installation

60.3048.14

Connector T - Inside Left



OPTIONAL
Accessory

Installation

60.3048.11

Connector T - Inside Left