

# FLOS

06.5024.40 White

## The Tracking Magnet Suspension Up&Down Profile Casambi / Dali / 1-10V compatible

Designed by FLOS Architectural, 2017



Electrical/mechanical profile for suspended installations.

Are you a professional and your project needs consulting and support?

[BOOK AN APPOINTMENT](#)

### Main specifications

Mounting	Suspension
Environments	Indoor dry location
Light sources included	no
LED type	Top LED
Lamp category	LED
Number of lamps	1
Power (W)	19.6
System power (W)	19.6
Source flux (lm)	1996.08
Lumen Output (lm)	1257
Efficacy (lm/W)	64.13

### Physical

Colour	White
Trim	No
Field cuttable	No
Length (mm)	3000
Net weight (kg)	4.18
IP internal	20
IP external	20



### Download

[Mounting instructions](#)  ZIP

### Photometric Files

[LDT / IES](#)  ZIP

### Technical Drawings

[2D](#)  ZIP

[3D](#)  ZIP

[Bim](#)  ZIP



## Schematic light drawing

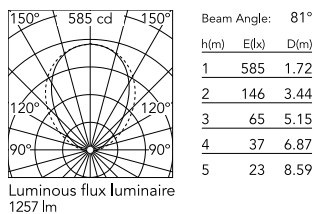

### Photometric

Lighting type	Indirect
Light distribution	Asymmetric
CCT (K)	3000
CRI>	80
McAdam steps (SDCM)	2
LED Life / Failure Ratio	L80B50 > 50.000h (Tc=85°C)
Beam angle C0-180 (°)	81
Beam angle C90-270 (°)	96
UGR <sub>L</sub>	<10

### Electrical

Insulation class	III
Forward voltage (V)	48
LED current (mA)	70
Power supply	Remote excluded
Dimmable	Yes
Power supply type	Non Dimmable, Dimmable
Emergency	No

### Notes

The linear elements in the Up&Down version include indirect LED lighting in the upper part of the profile. The magnetic profile and the Up lighting must be powered with the same equipment. Version compatible with "On board dimmer" luminaires and version compatible with system controlled luminaires (DALI, 1-10V, FLOS SMART CONTROL) available. Corners, connectors and accessories common for the two profile versions. Both versions have lengths of 1m-3m. The profiles cannot be cut. The covers must be ordered separately. 3m power cable included in all the linear power products. Suspension accessories (steel cable and rods) should be ordered separately. 90° corners available in the same plan (symmetrical element for left and right corners), common in Up&Down and Down versions. Not provided for connection to driver. The corners of the Suspended versions of Tracking Magnet do not have indirect lighting. Indirect lighting is controlled with a common circuit to the direct lighting.

## Accessories & Power Supply



REQUIRED  
Accessory

06.5026.40

The Tracking Magnet Suspension  
Up&Down Profile End Caps



REQUIRED  
Accessory

Electrical

08.0612.14

The Tracking Magnet Profile  
Intermediate Connector Straight



REQUIRED  
Accessory

Installation

08.8634.00

4m suspension steel cable

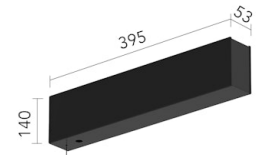

REQUIRED  
Power supply

Electrical

08.0632.14A

Surface power supply with driver  
included 320W / 48Vdc. DALI / No  
dim.



REQUIRED  
Power supply

Electrical

60.9607

LED power supply source for  
remote installation, 110Vac-150W  
/ 220Vac-200W

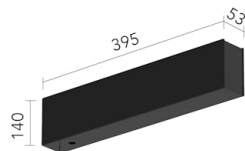

REQUIRED  
Power supply

Electrical

08.0632.40A

Surface power supply with driver  
included 320W / 48Vdc. DALI / No  
dim.



REQUIRED  
Control interface

Electrical

60.9678A

LED module Dali/Push dimmable  
control unit for 12, 24 or 48Vdc

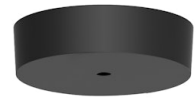

REQUIRED  
Accessory

08.8883.14A

Canopy surface Black, Power  
Supply not included order  
separately

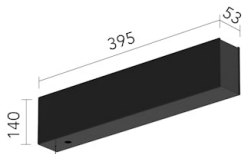

REQUIRED  
Power supply

Electrical

08.0631.40A

Surface power supply with driver included 320W / 48Vdc. 1-10V / 0-10V / No dim.

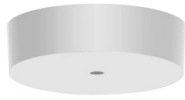

REQUIRED  
Accessory

08.8883.40A

Canopy surface White, Power Supply not included order separately



REQUIRED  
Electrical

08.8889.14

Recessed power supply rose



REQUIRED  
Electrical

06.1988.40

Multifunction Smart Device for Tracking Magnet & Infra-Structure



REQUIRED  
Control interface

Electrical

60.9395

LED module 1/10V dimmable control unit for 12 to 48V equipment.



REQUIRED  
Power supply

Electrical

60.9170

LED power supply source for remote installation, 48V/120W. 220/240 Vac

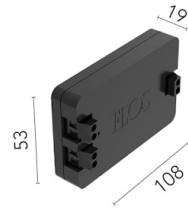

REQUIRED  
Power supply

Electrical

08.0613.14A

Dimmable control box 1-10V, 24/48V. For remote installation.



REQUIRED  
Electrical

08.8889.40

Recessed power supply rose



REQUIRED  
Accessory

Installation

60.3014.11

Suspension rod with 1m rose. M6 thread



REQUIRED  
Accessory

Electrical

08.0626.00

Power connector



REQUIRED  
Accessory

Installation

60.3014.14

1 m suspension rod with ceiling rose kit. M6 thread



REQUIRED  
Accessory

Installation

60.3097.11

1 m suspension rod with ceiling rose with m6 thread



REQUIRED  
Accessory

Installation

60.3097.14

1 m suspension rod extension set with m6 thread

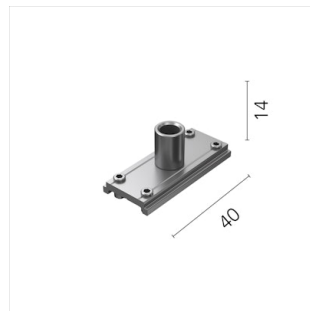

REQUIRED  
Accessory

Installation

08.0627.00

Intermediate suspension kit for joining profiles

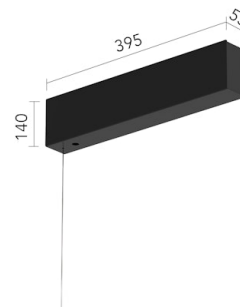

REQUIRED  
Power supply

Electrical

08.0631.14A

Surface power supply with driver included 320W / 48Vdc. 1-10V / 0-10V / No dim.



REQUIRED  
Power supply

Electrical

60.8919

LED Power Supply Source for remote installation. 48V/320W. 100/240 Vac