

FLOS

06.5020.05 Polished Aluminium

The Tracking Magnet Suspension Up&Down Profile Casambi / Dali / 1-10V compatible

Designed by FLOS Architectural, 2017



Electrical/mechanical profile for suspended installations.

Are you a professional and your project needs consulting and support?

[BOOK AN APPOINTMENT](#)

Main specifications

Mounting	Suspension
Environments	Indoor dry location
Light sources included	no
LED type	Top LED
Lamp category	LED
Number of lamps	1
Power (W)	6.5
System power (W)	6.8
Source flux (lm)	665.36
Lumen Output (lm)	419
Efficacy (lm/W)	61.62

Physical

Colour	Polished Aluminium
Trim	No
Field cuttable	No
Length (mm)	1000
Net weight (kg)	1.4
IP internal	20
IP external	20



Download

[Mounting instructions](#)  ZIP

Photometric Files

[LDT / IES](#)  ZIP

Technical Drawings

[2D](#)  ZIP

[3D](#)  ZIP

[Bim](#)  ZIP



Schematic light drawing

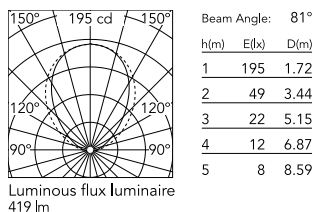

Photometric

Lighting type	Indirect
Light distribution	Asymmetric
CCT (K)	3000
CRI>	80
McAdam steps (SDCM)	2
LED Life / Failure Ratio	L80B50 > 50.000h (Tc=85°C)
Beam angle C0-180 (°)	81
Beam angle C90-270 (°)	96
UGR _L	<10

Electrical

Insulation class	III
Forward voltage (V)	48
LED current (mA)	70
Power supply	Remote excluded
Dimmable	Yes
Power supply type	Non Dimmable, Dimmable
Emergency	No

Notes

The linear elements in the Up&Down version include indirect LED lighting in the upper part of the profile. The magnetic profile and the Up lighting must be powered with the same equipment. Version compatible with "On board dimmer" luminaires and version compatible with system controlled luminaires (DALI, 1-10V, FLOS SMART CONTROL) available. Corners, connectors and accessories common for the two profile versions. Both versions have lengths of 1m-3m. The profiles cannot be cut. The covers must be ordered separately. 3m power cable included in all the linear power products. Suspension accessories (steel cable and rods) should be ordered separately. 90° corners available in the same plan (symmetrical element for left and right corners), common in Up&Down and Down versions. Not provided for connection to driver. The corners of the Suspended versions of Tracking Magnet do not have indirect lighting. Indirect lighting is controlled with a common circuit to the direct lighting.

Accessories & Power Supply

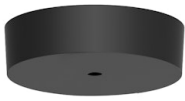

REQUIRED
Accessory

08.8883.14A

Canopy surface Black, Power Supply not included order separately



REQUIRED
Accessory

Electrical

08.0612.14

The Tracking Magnet Profile Intermediate Connector Straight



REQUIRED
Accessory

Installation

08.8634.00

4m suspension steel cable

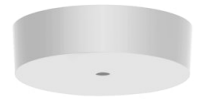

REQUIRED
Accessory

08.8883.40A

Canopy surface White, Power Supply not included order separately



REQUIRED
Electrical

08.8889.14

Recessed power supply rose

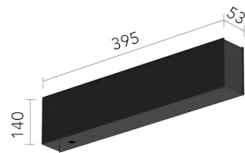

REQUIRED
Power supply

Electrical

08.0632.40A

Surface power supply with driver included 320W / 48Vdc. DALI / No dim.

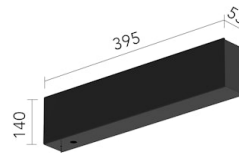

REQUIRED
Power supply

Electrical

08.0631.40A

Surface power supply with driver included 320W / 48Vdc. 1-10V / 0-10V / No dim.



REQUIRED
Control interface

Electrical

60.9395

LED module 1/10V dimmable control unit for 12 to 48V equipment.

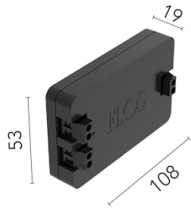

REQUIRED
Power supply
Electrical

08.0613.14A
Dimmable control box 1-10V,
24/48V. For remote installation.



REQUIRED
Electrical

08.8889.40
Recessed power supply rose



REQUIRED
Accessory
Installation

60.3014.11
Suspension rod with 1m rose. M6
thread



REQUIRED
Power supply
Electrical

60.9170
LED power supply source for
remote installation, 48V/120W.
220/240 Vac



REQUIRED
Accessory
Installation

60.3014.14
1 m suspension rod with ceiling
rose kit. M6 thread



REQUIRED
Control interface
Electrical

60.9678A
LED module Dali/Push dimmable
control unit for 12, 24 or 48Vdc



REQUIRED
Power supply
Electrical

60.9607
LED power supply source for
remote installation, 110Vac-150W
/ 220Vac-200W



REQUIRED
Electrical

06.1988.14
Multifunction Smart Device for
Tracking Magnet & Infra-Structure



REQUIRED
Accessory
Installation

60.3097.11

1 m suspension rod with ceiling
rose with m6 thread



REQUIRED
Electrical

06.1988.40

Multifunction Smart Device for
Tracking Magnet & Infra-Structure

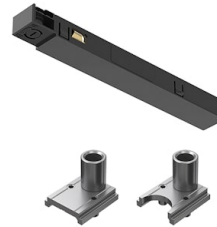

REQUIRED
Accessory
Electrical

08.0626.00

Power connector

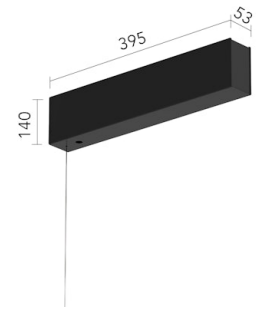

REQUIRED
Power supply
Electrical

08.0631.14A

Surface power supply with driver
included 320W / 48Vdc. 1-10V / 0-
10V / No dim.



REQUIRED
Accessory
Installation

60.3097.14

1 m suspension rod extension set
with m6 thread

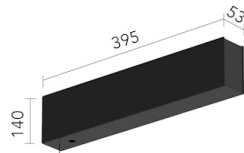

REQUIRED
Power supply
Electrical

08.0632.14A

Surface power supply with driver
included 320W / 48Vdc. DALI / No
dim.



REQUIRED
Power supply
Electrical

60.8919

LED Power Supply Source for
remote installation. 48V/320W.
100/240 Vac

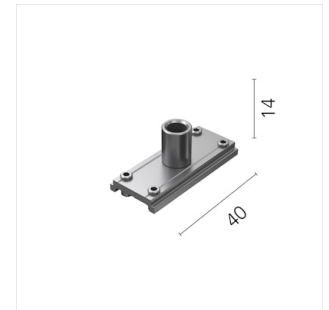

REQUIRED
Accessory
Installation

08.0627.00

Intermediate suspension kit for
joining profiles