

# FLOS

FA53909206 Grey

## Dooku 400 Single Top Pole Ø102 mm Street Optic

Designed by FLOS Outdoor, 2014



LED source included. Integrated power supply 220-240V ON/OFF and dimmable 1-10V or DALI. Fixing bracket included. Equipped with a 400mm protruding neoprene cable section and IP68 connectors. Smart-City version available upon request. Single socket for 102mm diameter post. The post must be ordered separately. Smart-City version available upon request.

Are you a professional and your project needs consulting and support?

[BOOK AN APPOINTMENT](#)

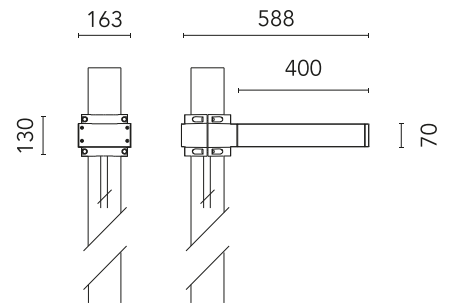

### Main specifications

EAN	8054793682754
Mounting	Pole Top
Environments	Outdoor wet location
Light source type	LED
Light sources included	Yes
LED type	Power LED
Number of lamps	1
Power (W)	34
System power (W)	39
Source flux (lm)	4122
Lumen Output (lm)	3102

### Physical

Colour	Grey
Orientation	Fixed
Net weight (kg)	5.36
Package height (mm)	605
Package width (mm)	175
Package length (mm)	150
Package volume (m3)	0.02
IP internal	65

### Download

[Mounting instructions](#)  ZIP

### Photometric Files

[LDT / IES](#)  ZIP

### Technical Drawings

[2D](#)  ZIP

[3D](#)  ZIP



## Schematic light drawing

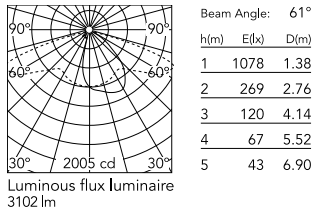

## Photometric

Light distribution	Asymmetric
CCT (K)	2700
CRI>	80
Extreme cut off	No

## Electrical

Insulation class	I
Frequency (Hz)	50/60
Main voltage (Vac)	220-240
Power supply	Integrated
Dimmable	No
Power supply type	Non Dimmable
Dimming interface	Not Dimmable
Emergency	No

## Notes

Please check with your referent person in our Front Office if a code modification is needed to meet the required certification compliance

## Ecodesign and Energy Labelling

This product contains a light source of energy efficiency class E



## Accessories & Power Supply



REQUIRED  
Pole

FA414006

Pole Ø 102 mm h 4000 mm With  
Base



REQUIRED  
Pole

FA414506

Pole Ø 102 mm h 4000 mm (+500  
mm In-ground)



REQUIRED  
Pole

FA415006

Pole Ø 102 mm h 5000 mm With  
Base



REQUIRED  
Pole

FA415506

Pole Ø 102 mm h 5000 mm (+500  
mm In-ground)



OPTIONAL  
Accessory

FA990E00A000

S.P.D. (SURGE PROTECTION  
DEVICE)



OPTIONAL  
Accessory

FA116

Base Plate and Fixing Bolts for  
Pole Ø 102 mm h 4000/5000 mm  
with Base