

RF27613

Arrangements Recessed ceiling wall assembly

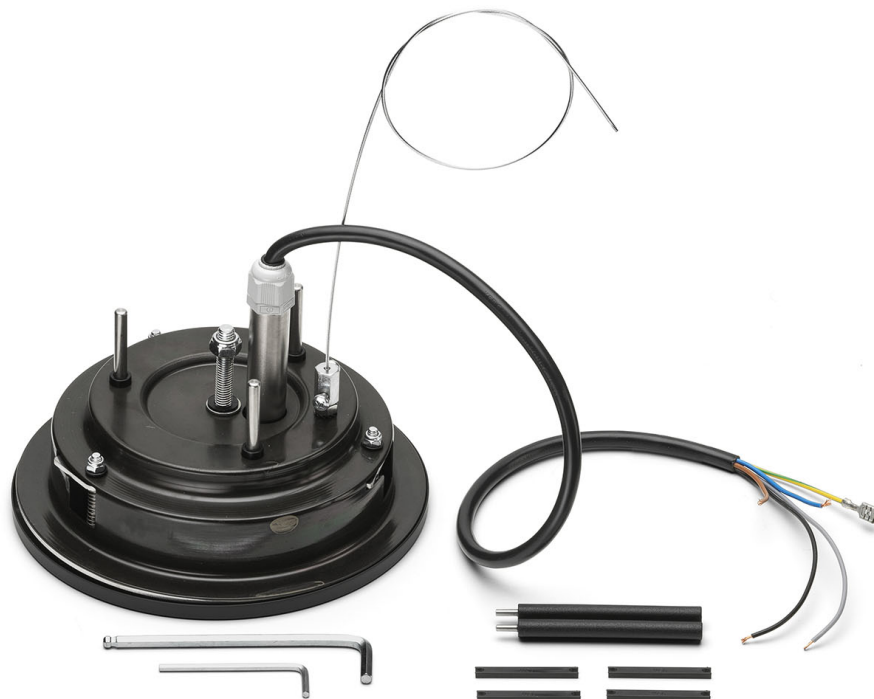

WARNING! When installing and whenever acting on the appliance, ensure that the power supply has been switched off.
For the installation of the spare-part, it is necessary to consult a qualified electrician.

RF27613

Arrangements Recessed ceiling wall assembly

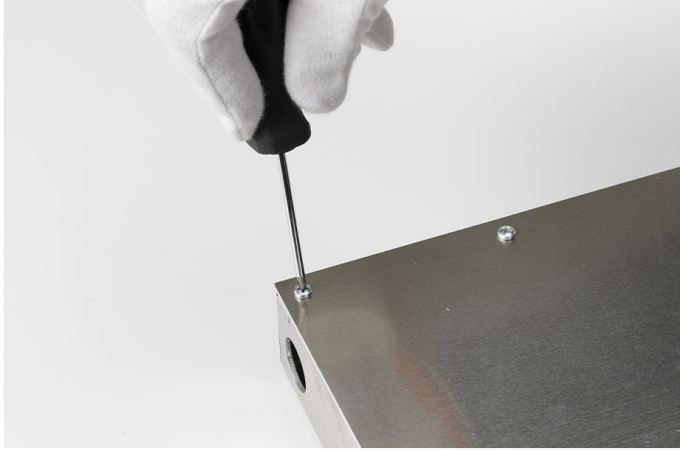

Fig.1

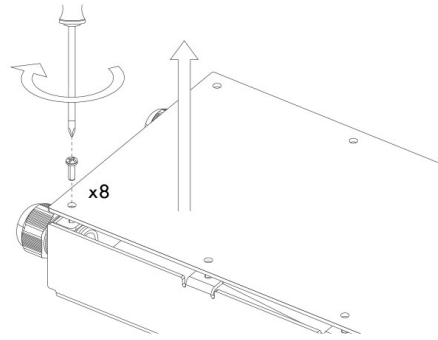

Fig.2

Remove the cover of the old power unit.

WARNING! When installing and whenever acting on the appliance, ensure that the power supply has been switched off.
For the installation of the spare-part, it is necessary to consult a qualified electrician.

RF27613

Arrangements Recessed ceiling wall assembly

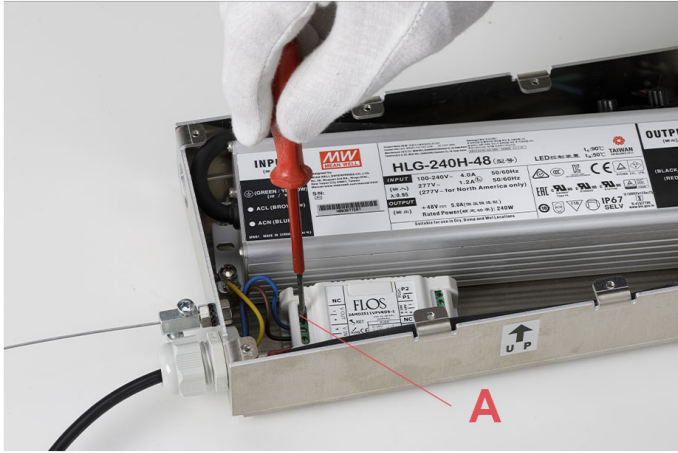

Fig.3

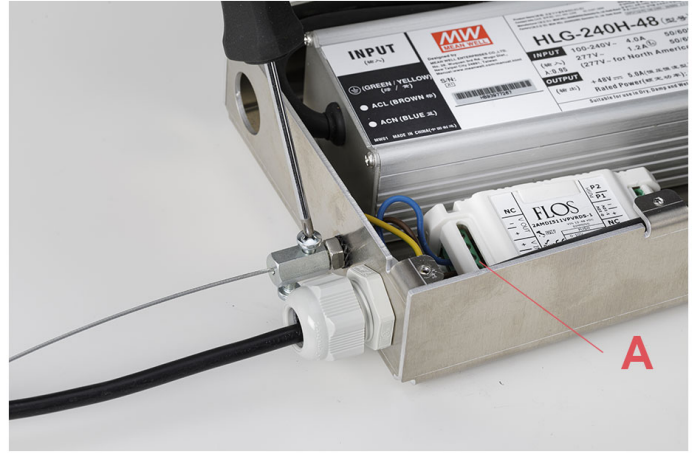

Fig.4

Disconnect the wires from the old dimmer (A) using a screwdriver.

WARNING! When installing and whenever acting on the appliance, ensure that the power supply has been switched off. For the installation of the spare-part, it is necessary to consult a qualified electrician.

RF27613

Arrangements Recessed ceiling wall assembly

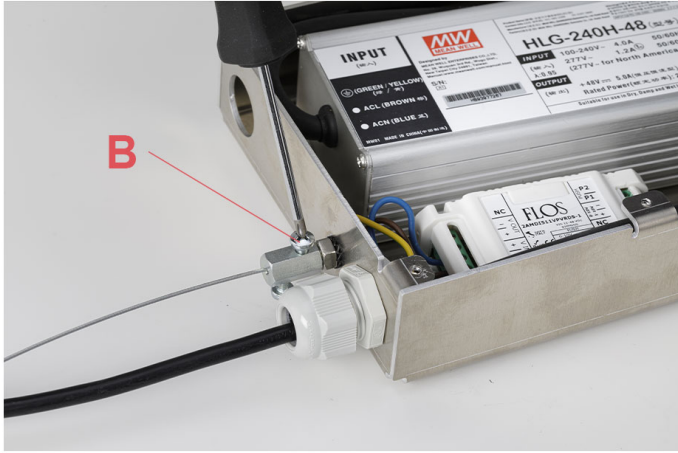

Fig.5

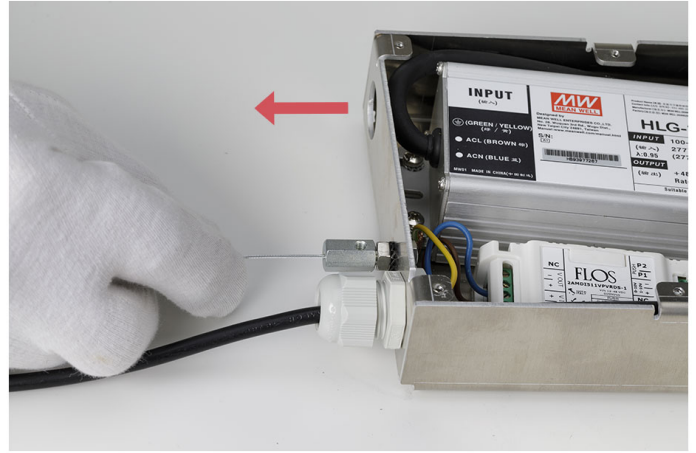

Fig.6

Unscrew the two screws (B) using a screwdriver.
Unthread the steel wire cable.

WARNING! When installing and whenever acting on the appliance, ensure that the power supply has been switched off.
For the installation of the spare-part, it is necessary to consult a qualified electrician.

RF27613

Arrangements Recessed ceiling wall assembly

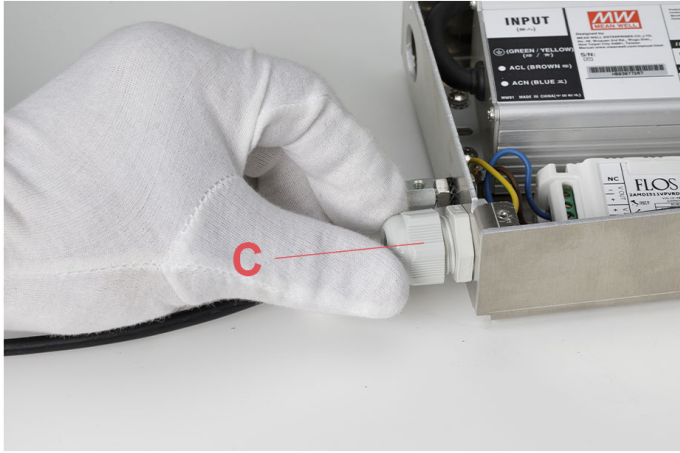

Fig.7



Fig.8

- Unscrew the cable clamp (C).(Fig.7)
- Unthread the electrical cable.(Fig.8)
- Insert the electrical cable of the new ceiling rose into the Power Unit. (Fig.8)
- Screw the cable clamp (C).(Fig.7)
- Screw the cable clamp (C).
- Insert the steel wire cable and fix it with the n°2 screws (B).(Fig.6 page 19)
- Connect the wires to the dimmer.
- Fasten the screws of the dimmer using a screwdriver.(Fig.3-4 page 18)
- Place the cover on the ceiling rose.
- Fasten the screws.(Fig.1-2 page 17).

WARNING! When installing and whenever acting on the appliance, ensure that the power supply has been switched off.
For the installation of the spare-part, it is necessary to consult a qualified electrician.